

## Pump Model CPS 250-200-320

Speed 1450rpm

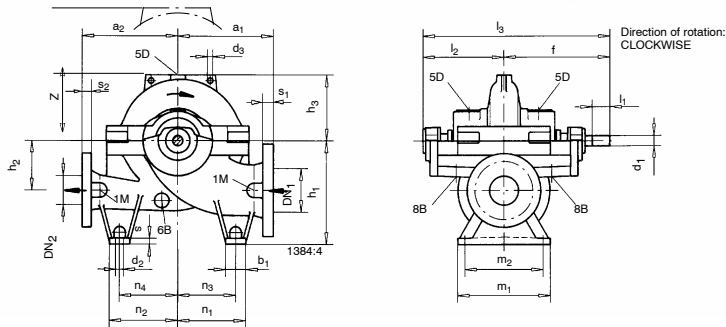
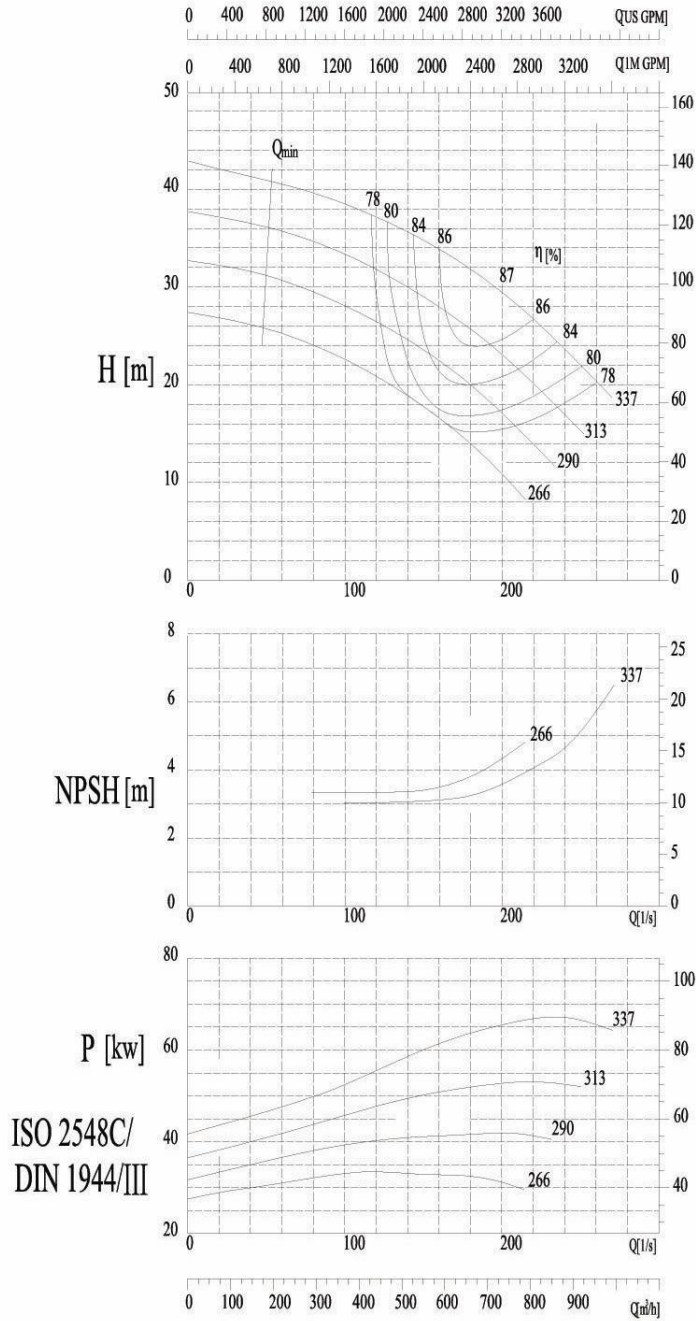

Pump Size	FLANGE DIMENSIONS				PUMP DIMENSIONS									
	DN1	DN2	s1	s2	a1	a2	d3	f	h1	h2	h3	l2	l3	z
CPS 250-200-320	250	200	47.6	41.3	450	450	24.5	590	500	240	285	399	989	570
	FOOT DIMENSIONS						SHAFT			PUMP WEIGHT				
	b1	d2	m1	m2	n1	n2	n3	n4	s	d1	L1	(kg)		
70	17.5	480	430	315	315	280	280	20	55	125	450			